

HRM520K1

F-19 LAME ROTATIVE

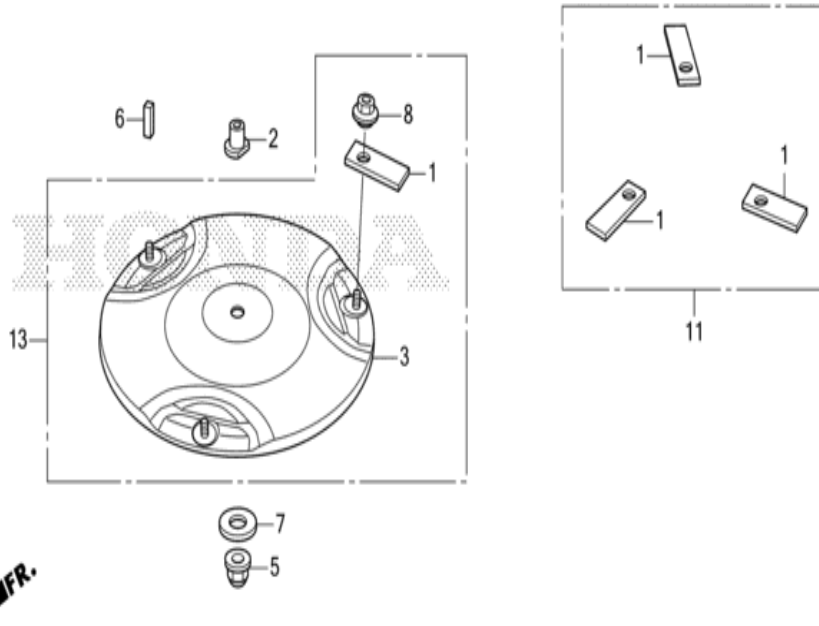

VP77F1900D

n° de référence	référence	Description	à partir de	jusqu'à	Qte unitaire	Qté commandée	Qté réparation
1	72511-VP7-030	LAME DE ROTOR		2030000	003	0	0
1	72511-VP7-C50	LAME DE ROTOR			003	0	0
1	72511-VP7-C50	LAME DE ROTOR	2030001		003	0	0
2	72611-VP7-000	SUPPORT, DISQUE LAME			001	0	0
3	72610-VP7-C50	COMP. DISQUES, LAME			001	0	0
3	72610-VP7-C50	COMP. DISQUES, LAME	2030001		001	0	0
5	90304-VP7-003	ECROU D'AUTO-BLOCANT, 8MM			001	0	0
6	90751-VP7-000	CLAVETTE PLATE, 4X4X14			001	0	0
7	90503-VP7-000	RONDELLE, 8.5X32X1.5			001	0	0
8	90305-VP7-000	ECROU, BALAI, 5MM		2030000	003	0	0
8	90305-VP7-C50	ECROU, BALAI, 5MM			003	0	0
8	90305-VP7-C50	ECROU, BALAI, 5MM	2030001		003	0	0
11	72515-VP7-A00	ENS. LAME, ROTATIVE		2030000	(1)	0	0
11	72515-VP7-C50	ENS. LAME, ROTATIVE			(1)	0	0
11	72515-VP7-C50	ENS. LAME, ROTATIVE	2030001		(1)	0	0
13	04403-VP7-C50	ENS. DISQUES, LAME			001	0	0