

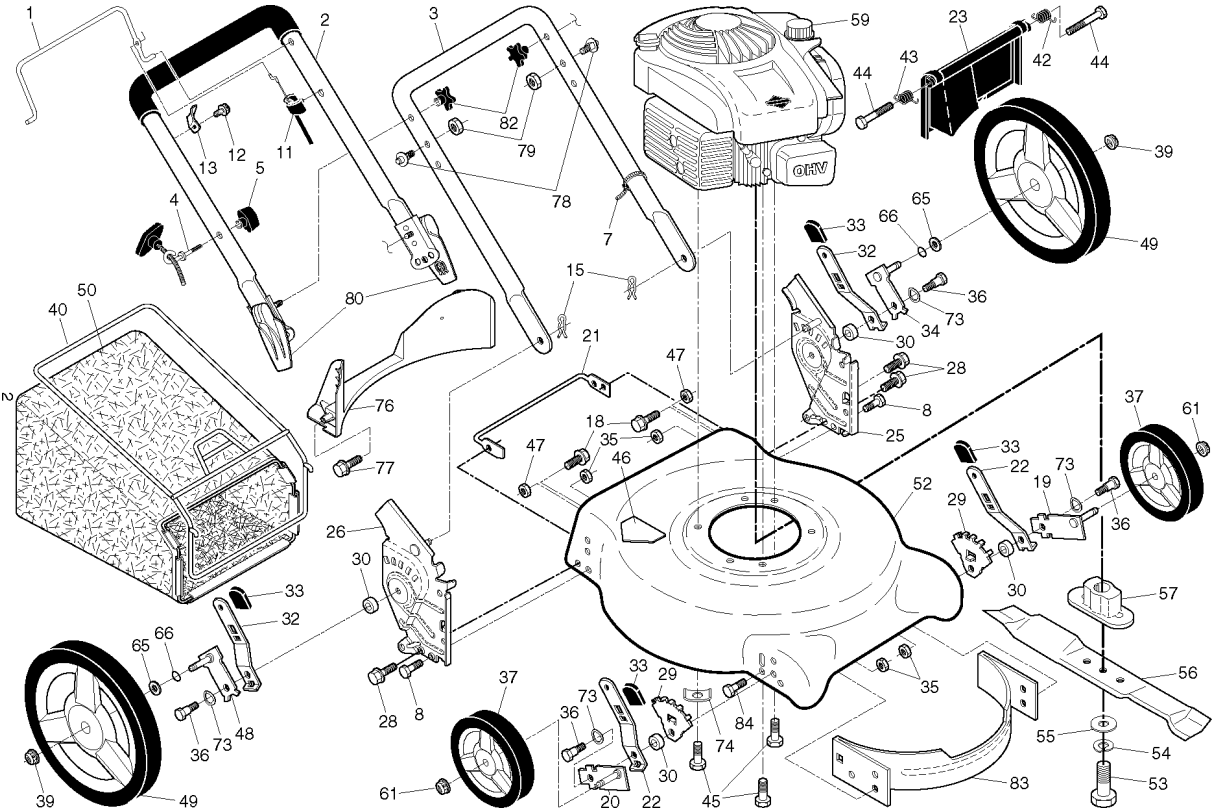

SPARE PARTS LIST

LAWN MOWERS: CONSUMER
WALK-BEHINDS

LC 153, 96131003702, 2016-08



Référence	Numéro de Pièce	Description	Remarque	QTÉ	Kit équipement
1	532 42 68-12	GUIDE-CHAÎNE		1	
2	583 84 86-03	POIGNÉE		1	
3	532 43 97-19	POIGNÉE		1	
4	581 90 21-01	GUIDE		1	
5	581 91 26-01	BOUTON		1	
7	532 06 64-26	HOOP		1	
8	874 78 05-12	VIS		1	
11	532 41 53-50	CABLE DE CONTRÔLE		1	
12	532 17 88-48	VIS		1	
13	532 43 00-34	SUPPORT		1	
15	532 05 17-93	AXE		1	
18	817 60 04-06	VIS		1	
19	532 40 66-89	AXE	FRONT, LEFT	1	
20	532 40 66-90	AXE	FRONT, RIGHT	1	
21	532 43 61-19	PROTECTEUR		1	
22	532 40 64-28	RESSORT		1	
23	581 42 56-01	PORTE		1	
25	588 91 24-06	ENSEMBLE DE SUPPORT DE POIGNEE	LH	1	
26	588 91 24-03	ENSEMBLE DE SUPPORT DE POIGNEE	RH	1	
28	817 06 04-10	VIS		1	
29	532 41 05-94	WHEEL ADJ BRACKET FRONT		1	
30	532 40 16-29	RONDELLE D'ESPACEMENT		1	
32	532 44 15-59	RESSORT		1	
33	532 70 10-37	BOUTON		1	
34	588 91 26-02	BRAS		1	
35	532 42 65-89	ÉCROU		1	
36	532 40 16-38	BOULON		1	
37	532 41 31-83	WHEEL AND TIRE ASSY, REAR		1	
39	532 40 91-49	ÉCROU		1	
40	532 41 19-49	CADRE		1	
42	532 40 54-21	RESSORT	LH	1	
43	532 40 54-23	RESSORT	RH	1	
44	532 18 41-93	BOULON		1	
45	532 15 04-06	BOULON		1	
46	532 18 21-66	DECAL		1	
47	873 75 11-53	ÉCROU		1	
48	588 91 26-02	BRAS		1	
49	588 26 86-02	ROUE		1	
50	581 00 21-04	BAC DE RAMASSAGE COMPLET		1	
52	532 44 19-82	KIT		1	46
53	532 85 10-84	VIS		1	
54	532 85 02-63	RONDELLE		1	
55	532 85 10-74	RONDELLE		1	
56	532 19 93-77	MOWER BLADE		1	
57	581 54 79-01	ADAPTATEUR		1	
59	000 00 00-00	W/O DESCRIPTION	B&S 93J02-0090-H1 FOR SERVICE & PARTS 1-800-233-3723	1	
61	532 40 91-48	ÉCROU		1	
65	532 08 83-48	RONDELLE		1	
66	532 19 74-80	JOINT TORIQUE		1	
73	532 40 16-30	RONDELLE		1	
74	532 12 50-78	RONDELLE		1	
76	532 41 05-89	BAFFLE.REAR.PLASTIC.21.RD.ECON		1	
77	817 41 13-12	VIS		1	
78	532 19 92-55	STYLO		1	
79	532 75 11-53	ÉCROU		1	
80	532 43 06-79	BOUTON		1	
82	532 18 23-98	BOUTON		1	
83	532 42 85-01	PLAQUE		1	
84	817 00 05-10	BOULON		1	
	532 18 21-91	LABEL WARNING	NOT SHOWN	1	
	581 00 67-04	SAC	NOT SHOWN	1	78 & 79